

Varenummer: 231111221
Beskrivelse: E+G Vertikal søjleoliestandsglas
HCL-400-M12

Mål

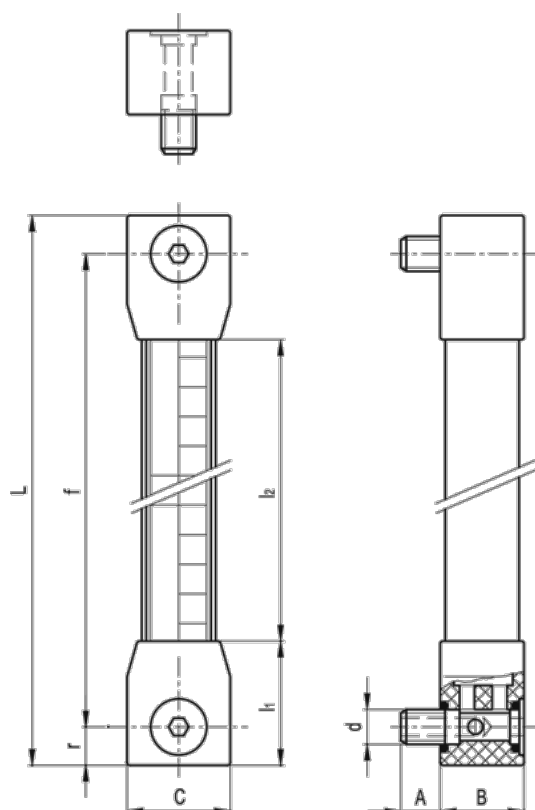

A = 13.5	r = 13
B = 28.5	Vægt (g) = 268
C = 35	
d = M12	
f = 400	
L = 426	
l1 = 42	
l2 = 342	